

## Features and Benefits

- The control circuit and RGB chip are integrated in a 5050 components, to form an external control pixel.
- **12V DC** power supply, can effectively reduce the operating current of the pixel LED, and decrease the voltage-drop of the PCB, this is to advance the consistency of the mixed lights for long-distance transmission.
- Using the built-in signal reshaping circuit to achieve the signal waveform shaping, and no distortion of waveform of signal takes place.
- The gray levels of each pixel are of 256 levels, which achieves “256\*256\*256=16777216” full-color display, and the refresh frequency reaches to 2KHz.
- Serial cascade interface, data receiving and decoding depend on just one signal line.
- Dual-signal wires version, signal break-point continuous transmission.
- Any two point the distance more than 5M transmission signal without any increase circuit.
- When the refresh rate is 30fps, cascade numbers is at least 1024 pixels.
- Data transmitting at speeds of up to 800Kbps.
- Good color consistency reliability, high cost-effective.

## Applications

- Guardrail tube series, point light display series, flexible/rigid strips series, module series applications.
- Lighting stage costumes, innovative gadgets or any other electronic products.

## General description

WS2815 is an intelligent control LED light source that the control circuit and RGB chip are integrated in a package of 5050 components. Its internal includes intelligent digital port data latch and signal reshaping amplification drive circuit.

**Dual-signal wires version**, signal break-point continuous transmission. Any pixel's failure won't affect signal transfer and total emitting effect.

The data transfer protocol use single NZR communication mode. After the pixel power-on reset, the DIN port receive data from controller, the first pixel collect initial 24bit data then sent to the internal data latch, the other data which reshaping by the internal signal reshaping amplification circuit sent to the next cascade pixel through the DO port. After transmission for each pixel, the signal to reduce 24bit. Every pixel adopts auto-reshaping transmit technology, making the pixel cascade numbers are not limited to the signal transmission, only relate to the speed of signal transmission.

The BIN receives the data signal, and then compare the data with the DIN side after phagocytosis of 24bit data, if DIN do NOT receive the signal, then switching to BIN for receiving the input signal, which ensure that any the IC's damage does not affect the signal cascade transmission and make the BIN in state of receiving signal until restart after power-off.

Refresh Frequency updates to **2KHz**, Low Frame Frequency and no Flicker appear in HD Video Camera.

RESET time > **280μs**, it won't cause wrong reset while interruption, it supports the lower frequency and inexpensive MCU.

Integrated circuit chips enable the circuit control simpler, neater and more reliable while NO extra components needed.

**Mechanical Dimensions**

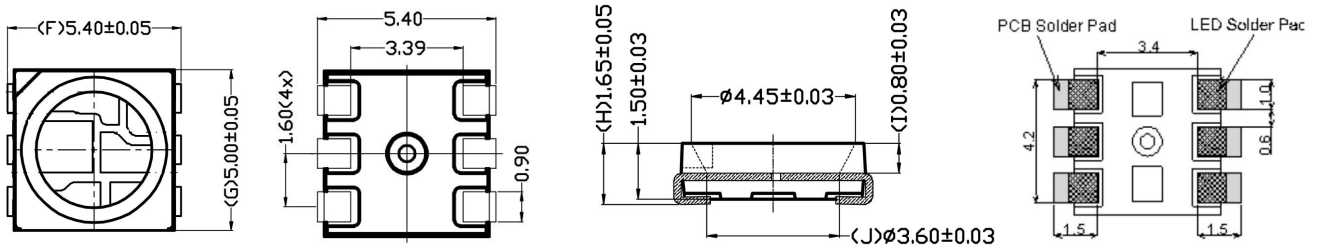

**PIN Configuration**

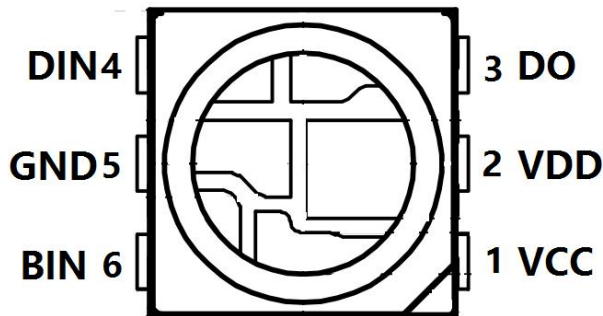

**PIN Function**

NO.	Symbol	PIN	Function description
1	VCC	VCC	IC POWER SUPPLY, Suspended or connected with a filter capacitor to GROUND
2	VDD	VDD	LED POWER SUPPLY, connect to “+12V”
3	DO	DO	Control data signal output
4	DIN	DIN	Control data signal input
5	GND	GND	Data & Power Grounding
6	BIN	BIN	Backup Control data signal input

**Absolute Maximum Ratings**

Parameter	Symbol	Ratings	Unit
Power supply voltage	V <sub>DD</sub>	+9.5~+13.5	V
Input voltage	V <sub>I</sub>	-0.5~VCC+0.5	V
Operating Temperature	T <sub>opt</sub>	-25~+85	°C
Storage Temperature	T <sub>stg</sub>	-40~+105	°C

**Electrical Characteristics (TA=-20~+70°C, VDD=4.5~5.5V, VSS=0V)**

Parameter	Symbol	Min.	Tpy.	Max.	Unit	Conditions
Input Current	I <sub>I</sub>	---	---	±1	μA	V <sub>I</sub> =VDD/VSS
High-level Input	V <sub>IH</sub>	0.7VDD	---	---	V	D <sub>IN</sub> , SET
Low-level Input	V <sub>IL</sub>	---	---	0.3 VDD	V	D <sub>IN</sub> , SET
Hysteresis voltage	V <sub>H</sub>	---	0.35	---	V	D <sub>IN</sub> , SET

**Switching Characteristics (TA=-20~+70°C, VDD=4.5~5.5V, VSS=0V)**

Parameter	Symbol	Condition	Min	Tpy	Max	Unit
Transmission Delay Time	t <sub>PLZ</sub>	CL=15pF, DIN→DOUT, RL=10KΩ	---	---	300	ns
Fall time	t <sub>THZ</sub>	CL=300pF, OUTR/OUTG/OUTB	---	---	120	μs
Input-capacitance	C <sub>I</sub>	---	---	---	15	pF

**LED Characteristics**

	Ref. Value
Quiescent Current	2.1mA
RGB Channel Constant Current	15mA
<b>RED</b> Brightness (Central Value)	360mcd
<b>GREEN</b> Brightness (Central Value)	1150mcd
<b>BLUE</b> Brightness (Central Value)	220mcd
WHITE Brightness (Central Value)	1710mcd
<b>RED</b> Wavelength	620-625nm
<b>GREEN</b> Wavelength	515-525nm
<b>BLUE</b> Wavelength	465-475nm

**Data Transfer Time**

<b>T0H</b>	0-code, High-level time	220ns~380ns
<b>T1H</b>	1-code, High-level time	580ns~1.6μs
<b>T0L</b>	0-code, Low-level time	580ns~1.6μs
<b>T1L</b>	1-code, Low-level time	220ns~420ns
<b>RES</b>	Frame unit, Low-level time	> 280μs

**Sequence chart**

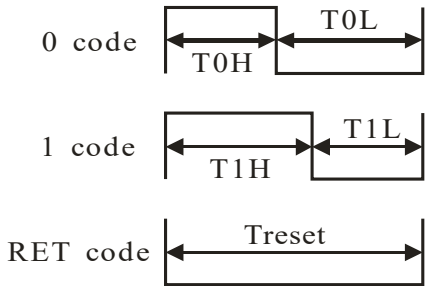

**Cascade method**

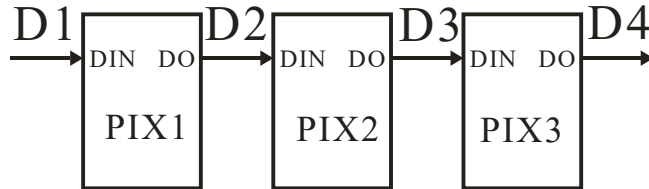

**Data Transmission Method**

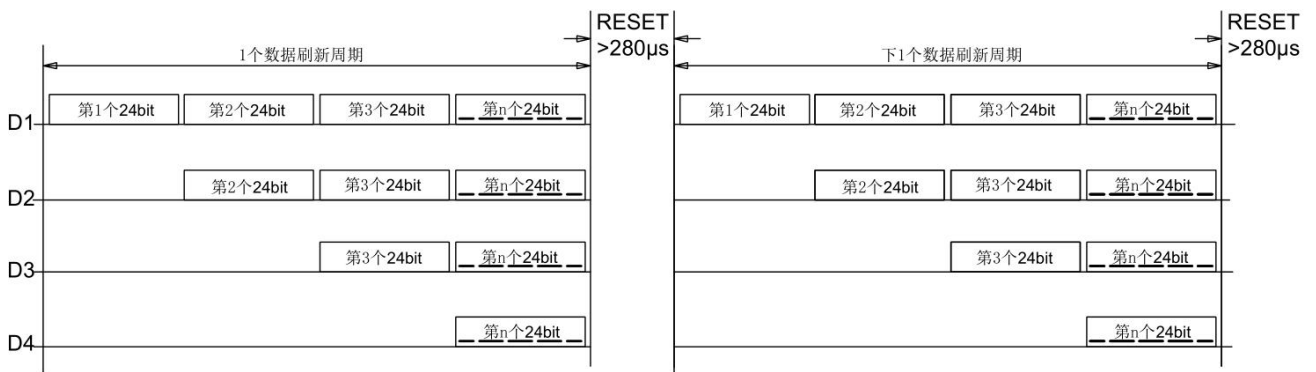

Note: D1 is the data from MCU, and D2, D3, D4 are from Cascade Circuits.

**Composition of 24bit data**

G7	G6	G5	G4	G3	G2	G1	G0	R7	R6	R5	R4	R3	R2	R1	R0	B7	B6	B5	B4	B3	B2	B1	B0
----	----	----	----	----	----	----	----	----	----	----	----	----	----	----	----	----	----	----	----	----	----	----	----

Note: Data transmit in order of GRB, high bit data is first.

**Typical application circuit**

**1. Recommended application circuit**

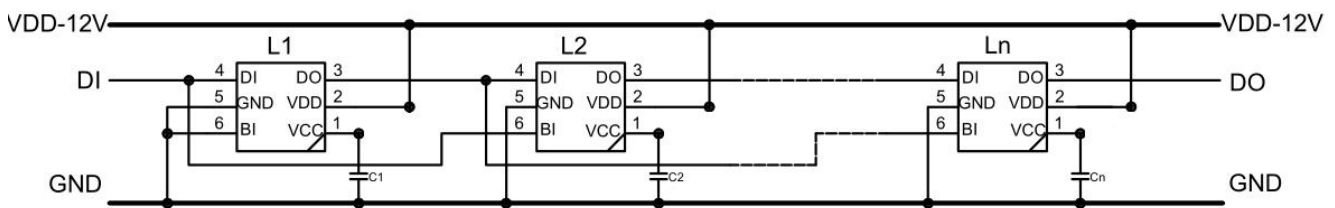

Remarks: C1 is bypass filter capacitor, its value of 100NF.

**2. For complicated wiring & space-saving**

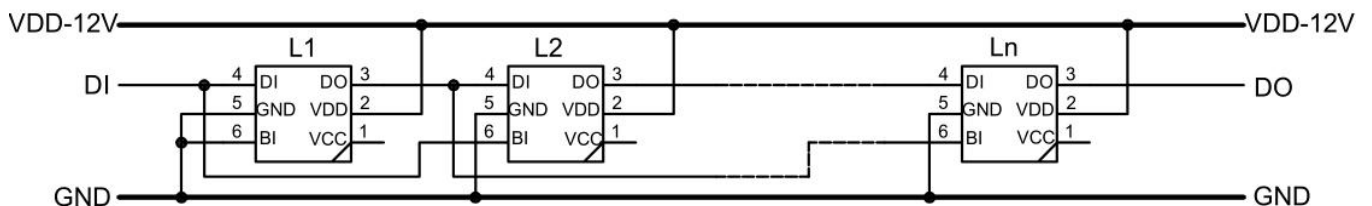

**Lead-free Reflow Instructions/SMT**

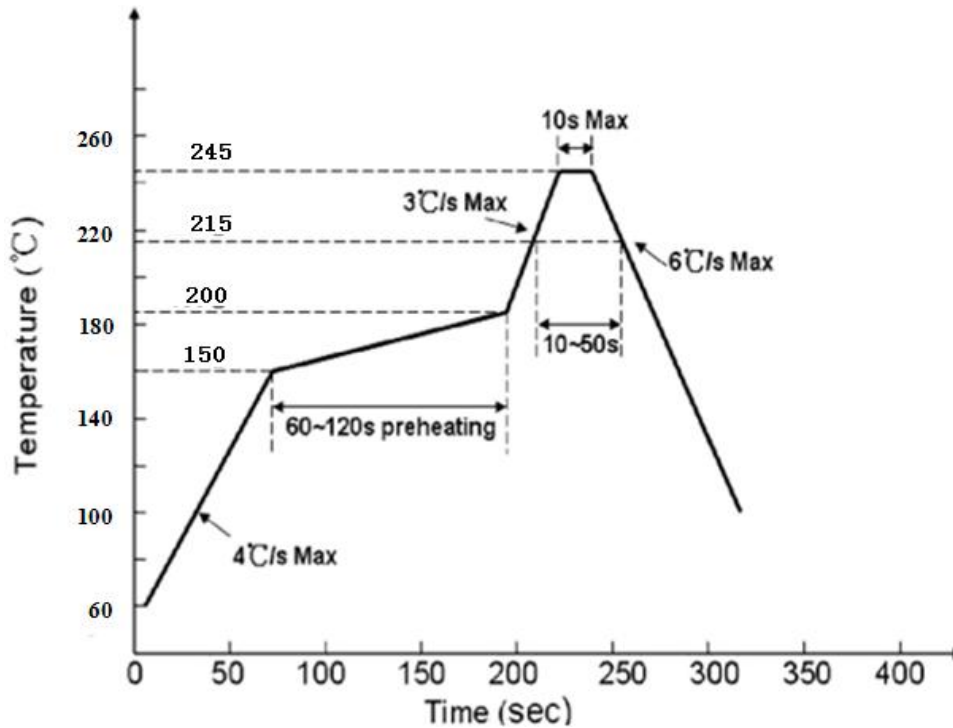

Curve Description	Lead-free Reflow Solder/SMT
The lowest preheat temperature (T <sub>min</sub> )	150°C
The highest preheat temperature (T <sub>max</sub> )	200°C
Preheating time (T <sub>min</sub> to T <sub>max</sub> ) (ts)	60-180 S
Average rate of temperature rise (T <sub>max</sub> to T <sub>p</sub> )	<3°C/S
LIQUID REGION temperature (TL)	217°C
LIQUID REGION Holding Time (tL)	60-150 S
Peak Temperature (T <sub>p</sub> )	245 °C
High Temperature Region(T <sub>p</sub> -5°C) Holding Time (tp)	<10 S
Cooling Rate	<6°C/S
Room Temperature to Peak Holding Time	<6 min

◆ **Remarks**

1. This has to be baked for 48 hours at the baking temperature of 70-75°C before being used.
2. Use up with 2 hours after taking out from oven.
3. Please replace the unused LEDs into oven.

◆ **Reflow instruction**

1. No more than two times of reflow.
2. Do not beat the colloid surface when the material is heated.

◆ **Manual Soldering instruction**

1. Soldering iron's temperature must be under 300°C, and operating time must be less than 3 seconds.
2. It should be done only once for the manual soldering.

◆ **Repairing instruction**

Normally, it can't be repaired after reflow. You need to use double-ended solder iron and make sure that whether it will do damage to the LEDs' characteristics when repairing is inevitable.

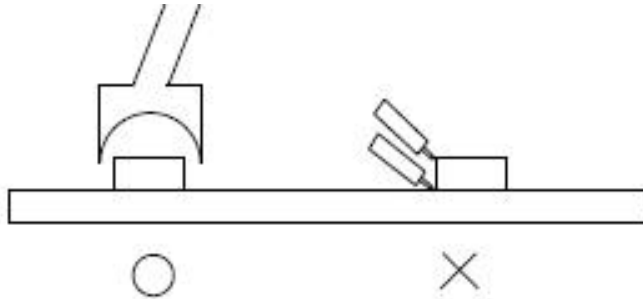

◆ **Storing and Transporting**

1. Scope of application

Front side up, moisture-proof and waterproof, no extrusion, no collision and no vibration.

2. Storage and its period

- ① Room temperature sealed storage: 20°C~30°C, 40%~60%RH, product is valid for ONE week.
- ② Moisture-proof sealed storage: 20°C~30°C, 25%~60%RH, product is valid for TWO weeks.
- ③ Use up with 2 hours after removing from packages.(Environmental conditions for temperature <30°C,

relative humidity<60%)

◆ **Dehumidification**

We would recommend to do dehumidification if they exceed the valid storage period of products or dampened due to other reasons.

Dehumidification Method: 70°C-75°C/48±2 Hours

◆ **Electrostatic Protection**

LED is an electrostatic sensitive component, although the LED products are with excellent anti-static ability, they will cause a certain damage by any electrostatic discharge. By taking some electrostatic measures to avoid the damages when using the LEDs, such as wearing anti-static gloves and anti-static bracelet, etc..

◆ **Precautions**

Pressing the colloid surface will affect the reliability of LED because the LED is advanced silicone-gel. And therefore precautions should be taken to avoid the strong pressure on the component. It's proper to make the LED be used in safe condition when using a suction nozzle. Silicon packing with soft and elastic, it greatly reduces thermal stresses and unable to bear external mechanical forces. Therefore, preventive measures should be taken in process of manually handling.

- ① Clip the LED from its side.

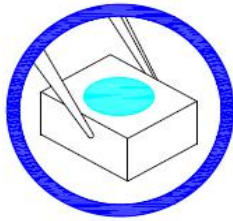

- ② Neither directly touch the gel surface with the hand or sharp instrument, it may damage its internal circuit.

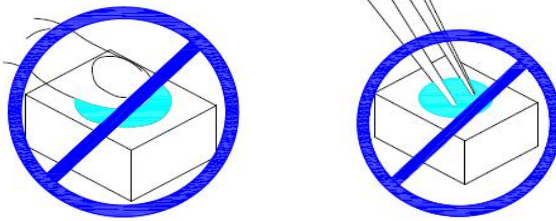

- ③ Not to be double stacked, it may damage its internal circuit.

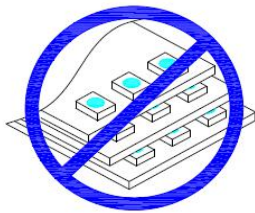

- ④ Can not be stored in or applied in the acidic sites of PH<7.



**Carrier tape (Unit: mm)**

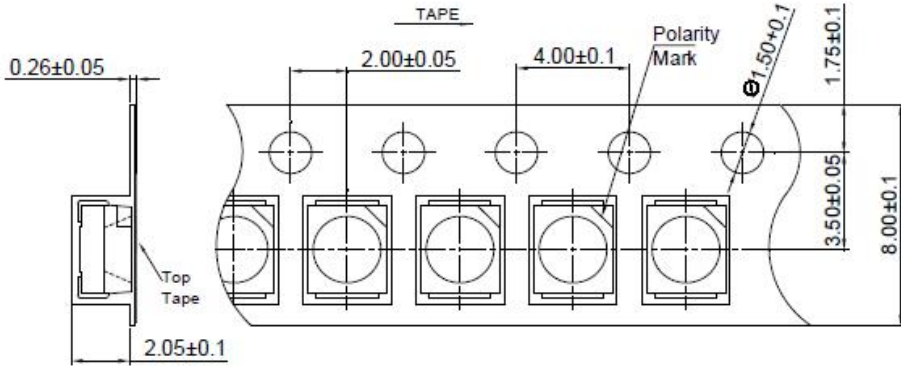

**Reel size (Unit: mm)**

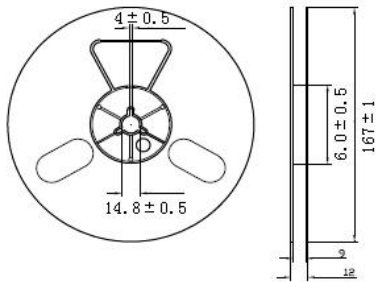

**Moisture-proof bag**

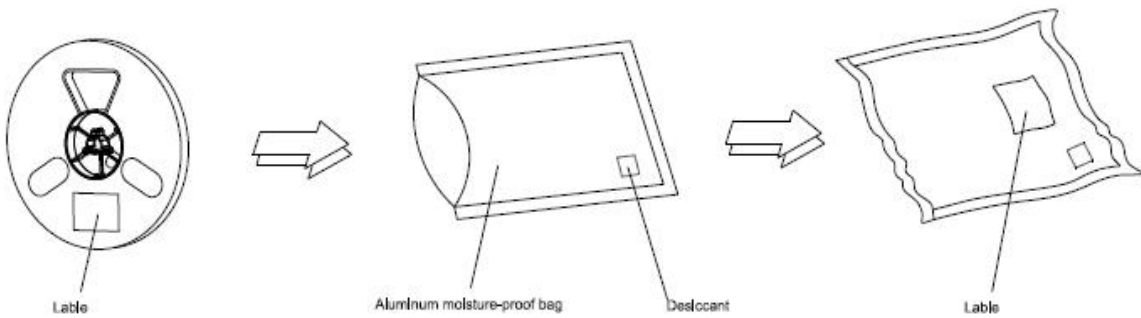

**Modify Records**

Version №	Status Bar	Modify Content Summary	Date	Reviser	Approved
V1.0	N	New	20170523	Shen JinGuo	Yin HuaPing

Remarks: Initial version: V1.0; Version number plus "0.1" after each revision;

Status bar: N--New, A--Add, M--Modify, D--Delete.